

Vlier Locating Pins

Steel Nose with Plastic Knob

All Vlier locating pins include a jam nut.

Typical Uses

- Positioning
- Fastening
- Securing
- With Thread Lock
- Latching
- Quick disconnect

Material







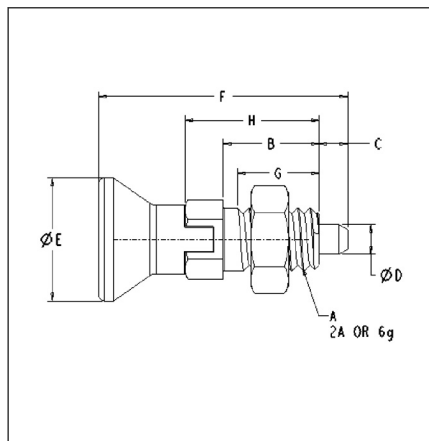

















- Steel: Carbon Steel
- Plastic Knob: Thermoplastic
- (Nylon 6)

Finishes

- Steel: Black Oxide
- Plastic Knob: Black Gray



Vlier Locating Pins - Steel Nose w/ Plastic Knob - w/ Thread Lock &

Part No.		End Force, (Lbs.)		A	B	C	D	E	F	G	H	ROHS	CAD
		Initial	Final										
PKLT250A 	PKLTL250A 	1.00	2.25	1/4-28	0.472	0.138	0.118	0.55	1.22	0.39	0.67	<input checked="" type="checkbox"/>	PKLT250A 
PKLT312A 	PKLTL312A 	1.35	2.70	5/16-24	0.591	0.158	0.158	0.71	1.50	0.51	0.83	<input checked="" type="checkbox"/>	PKLT312A 
PKLT375A 	PKLTL375A 	1.10	2.70	3/8-24	0.669	0.197	0.197	0.83	1.70	0.59	0.94	<input checked="" type="checkbox"/>	PKLT375A 
PKLT500 	PKLTL500 	1.35	3.15	1/2-13	0.787	0.236	0.236	0.98	2.02	0.63	1.10	<input checked="" type="checkbox"/>	PKLT500 
PKLT625 	PKLTL625 	3.37	7.87	5/8-11	1.024	0.315	0.315	1.30	2.65	0.83	1.42	<input checked="" type="checkbox"/>	PKLT625 
PKLT750 	PKLTL750 	3.37	9.00	3/4-10	1.102	0.394	0.394	1.30	2.89	0.91	1.57	<input checked="" type="checkbox"/>	PKLT750 
PKLT750A 	PKLTL750A 	3.37	8.77	3/4-16	1.102	0.472	0.472	1.30	3.04	0.98	1.65	<input checked="" type="checkbox"/>	PKLT750A 
PKLT1000 	PKLTL1000 	4.50	10.30	1-8	1.260	0.630	0.630	1.57	3.74	1.10	1.97	<input checked="" type="checkbox"/>	PKLT1000 

Product not available in metric.

Proud to be [ISO:50001](#) and [ISO:9001](#) Certified

Cage Code: 01226



Copyright © 2024 Vlier Inc. | All Rights Reserved | A Division of  HUTCHINSON®