

Leveling Devices

High Value Series Stud Style Extended Length w/ Elastomer Pad Steel w/ Gold Chromate Finish

Vlier's high value series stud style extended length with elastomer pad leveling devices are of premium quality construction, with optimum plating, finishing and cosmetics. These steel levelers provide an integrally machined stud as part of the ball. The stud style bases swivel 15° off the centerline to adjust to uneven surfaces and level machine tools, electronic racks, benches, data storage, power generation, machine centers and others. The standard steel design is zinc plate with gold chromate finish.

Typical Uses







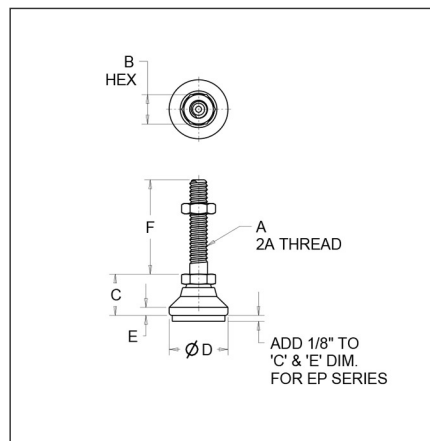





















- Data storage equipment
- Large medical equipment
- Material handling equipment
- Industrial workstations
- Industrial machines

Special Features

- Hardened ball
- Extended stud with integrally machined hex
- Large diameter base support
- 15° swivel off centerline



High Value Series Stud Style Extended Length w/ Elastomer Pad - Steel w/ Gold Chroma Finish

Part No.	Max Load (lbs.)	A	B	C*	D	E	F	ROHS	CAD
HVEP298S 	525	10-32	3/8	0.53	3/4	0.11	1	<input checked="" type="checkbox"/>	HVEP298S 
HVEP299S 	525	10-32	3/8	0.53	3/4	0.11	2	<input checked="" type="checkbox"/>	HVEP299S 
HVEP300S 	800	1/4-20	1/2	0.7	1	0.15	1-1/4	<input checked="" type="checkbox"/>	HVEP300S 
HVEP301S 	800	1/4-20	1/2	0.7	1	0.15	2-1/2	<input checked="" type="checkbox"/>	HVEP301S 
HVEP304S 	2,800	3/8-16	5/8	7/8	1-1/4	0.17	2	<input checked="" type="checkbox"/>	HVEP304S 
HVEP305S 	2,800	3/8-16	5/8	7/8	1-1/4	0.17	4	<input checked="" type="checkbox"/>	HVEP305S 
HVEP306S 	3,750	1/2-13	3/4	1-1/8	1-7/8	0.25	2	<input checked="" type="checkbox"/>	HVEP306S 
HVEP307S 	3,750	1/2-13	3/4	1-1/8	1-7/8	0.25	4	<input checked="" type="checkbox"/>	HVEP307S 
HVEP308S 	4,500	5/8-11	7/8	1-1/4	2-1/2	0.31	2	<input checked="" type="checkbox"/>	HVEP308S 
HVEP309S 	4,500	5/8-11	7/8	1-1/4	2-1/2	0.31	4	<input checked="" type="checkbox"/>	HVEP309S 
HVEP310S 	5,400	3/4-10	1-1/16	1-1/2	3	0.5	2	<input checked="" type="checkbox"/>	HVEP310S 
HVEP311S 	5,400	3/4-10	1-1/16	1-1/2	3	0.5	4	<input checked="" type="checkbox"/>	HVEP311S 
HVEP312S 	16,000	1-8	1-3/8	1-7/8	4	0.4	4-1/4	<input checked="" type="checkbox"/>	HVEP312S 
HVEP313S 	16,000	1-8	1-3/8	1-7/8	4	0.4	8	<input checked="" type="checkbox"/>	HVEP313S 

This product is unavailable in Metric.

Proud to be [ISO:50001](#) and [ISO:9001](#) Certified

Cage Code: 01226



Copyright © 2024 Vliet Inc. | All Rights Reserved | A Division of  HUTCHINSON®