

Expanded Long Travel Round Nose Plungers

Expanded Metric

Expanded long travel round nose plungers are ideal for high-speed, long-life applications. They are easily inserted, adjusted and removed with a standard wrench from plunger end. The slotted plunger body on this long travel plunger allows for blind hole installation.

Typical Uses

- Positioning
- Indexing
- Ejecting
- With Thread Lock
- Latching
- Detents
- Contacts
- Lifters
- Insulators





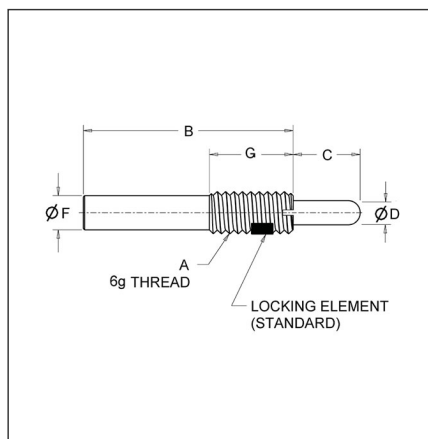

















Special Features

- Impact resistance
- Choice of spring forces
- 10mm to 24mm
- Choice of with or without locking elements





Product not available in inch

Expanded Long Travel Round Nose Plungers w/ Thread Lock

Part No.	End Force, N		A	B	C	ØD	E	ØF	G	ROHS
	Initial	Final								
HHL10 	6.0	16.0	M10	35.0	8.0	4.0	3.0	7.8	25.0	<input checked="" type="checkbox"/>
HHL12 	4.0	18.0	M12	43.0	10.0	5.5	4.0	9.5	35.0	<input checked="" type="checkbox"/>
HHLH12 	7.0	46.0	M12	43.0	10.0	5.5	4.0	9.5	35.0	<input checked="" type="checkbox"/>
HHL16A 	7.0	24.0	M16	48.0	10.0	8.0	6.0	13.4	35.0	<input checked="" type="checkbox"/>
HHLH16A 	10.0	43.0	M16	48.0	10.0	8.0	6.0	13.4	35.0	<input checked="" type="checkbox"/>
HHL16B 	15.0	42.0	M16	58.0	10.0	8.0	6.0	13.4	35.0	<input checked="" type="checkbox"/>
HHLH16B 	14.0	84.0	M16	58.0	10.0	8.0	6.0	13.4	35.0	<input checked="" type="checkbox"/>
HHL16C 	9.0	33.0	M16	58.0	15.0	8.0	6.0	13.4	35.0	<input checked="" type="checkbox"/>
HHLH16C 	10.0	57.0	M16	58.0	15.0	8.0	6.0	13.4	35.0	<input checked="" type="checkbox"/>
HHL16D 	4.0	23.0	M16	58.0	20.0	8.0	6.0	13.4	35.0	<input checked="" type="checkbox"/>
HHL16E 	11.0	43.0	M16	83.0	20.0	8.0	6.0	13.4	35.0	<input checked="" type="checkbox"/>
HHLH16E 	18.0	72.0	M16	83.0	20.0	8.0	6.0	13.4	35.0	<input checked="" type="checkbox"/>
HHL16F 	13.0	41.0	M16	98.0	25.0	8.0	6.0	13.4	35.0	<input checked="" type="checkbox"/>
HHLH16F 	20.0	70.0	M16	98.0	25.0	8.0	6.0	13.4	35.0	<input checked="" type="checkbox"/>
HHL16G 	13.0	47.0	M16	98.0	30.0	8.0	6.0	13.4	35.0	<input checked="" type="checkbox"/>
HHLH16G 	20.0	80.0	M16	98.0	30.0	8.0	6.0	13.4	35.0	<input checked="" type="checkbox"/>
HHL16H 	24.0	110.0	M16	118.0	30.0	8.0	6.0	13.4	35.0	<input checked="" type="checkbox"/>
HHL16K 	13.0	63.0	M16	148.0	40.0	8.0	6.0	13.4	35.0	<input checked="" type="checkbox"/>
HHLH16K 	21.0	113.0	M16	148.0	40.0	8.0	6.0	13.4	35.0	<input checked="" type="checkbox"/>
HHL16L 	7.0	43.0	M16	148.0	50.0	8.0	6.0	13.4	35.0	<input checked="" type="checkbox"/>
HHLH16L 	13.0	75.0	M16	148.0	50.0	8.0	6.0	13.4	35.0	<input checked="" type="checkbox"/>
HHL24 	14.0	87.0	M24	60.0	15.0	10.0	8.0	19.6	45.0	<input checked="" type="checkbox"/>
HHLH24 	24.0	192.0	M24	60.0	15.0	10.0	8.0	19.6	45.0	<input checked="" type="checkbox"/>

Expanded Long Travel Round Nose Plungers without Thread Lock

Part No.	End Force, N		A	B	C	ØD	E	ØF	G	ROHS
	Initial	Final								
HTHL16A 	17.0	74.0	M16	80.0	11.0	7.3	8.0	13.4	35.0	<input checked="" type="checkbox"/>
HTHL16B 	21.0	81.0	M16	120.0	21.0	7.3	8.0	13.4	35.0	<input checked="" type="checkbox"/>

HTHL16C		21.0	89.0	M16	150.0	31.0	7.3	8.0	13.4	35.0	<input checked="" type="checkbox"/>
HTHL16D		16.0	80.0	M16	200.0	41.0	7.3	8.0	13.4	35.0	<input checked="" type="checkbox"/>
HTHL22A		80.0	214.0	M22	130.0	21.0	9.0	8.0	19.0	50.0	<input checked="" type="checkbox"/>
HTHL22B		70.0	210.0	M22	168.0	31.0	9.0	8.0	19.0	50.0	<input checked="" type="checkbox"/>
HTHL22C		76.0	208.0	M22	226.0	41.0	9.0	8.0	19.0	50.0	<input checked="" type="checkbox"/>

Proud to be [ISO:50001](#) and ISO:9001 Certified
Cage Code: 01226



Copyright © 2024 Vlier Inc. | All Rights Reserved | A Division of  | HUTCHINSON®