

System

System Components

From the simplest to the most complex hydraulic system, Enerpac's system components help you complete your design. Gauges, pressure switches, couplers and hoses are simple but necessary items for any hydraulic system, and Enerpac can provide the full range.









Technical support

- Safety instructions
- Basic hydraulic information
- Advanced hydraulic technology
- FMS (Flexible Machining Systems) technology
- Conversion charts and hydraulic symbols

 197 ▶

components

| | ▼ series | ▼ page | |
|--------------------------------------|----------------------|---------|---|
| Pressure switches | IC, PB PSCK | 188 |  |
| Digital pressure gauges | DG | 189 |  |
| Pressure gauges | G | 190 |  |
| Gauge accessories | GA, GS NV, FM | 191 |  |
| Manifolds, couplers, hoses, tubing | A, AH/R HLS, H, T | 192 |  |
| High pressure filters, hydraulic oil | FL, HF | 193 |  |
| High pressure fittings | BFZ, FZ | 194-196 |  |

Shown: PSCK-8, IC-51



Enerpac remote mounted pressure switches monitor the hydraulic system to determine any change of pressure. The signal can then be used to control the pump, or other peripheral devices.

IC-series

The IC-series electrical pressure switches provide pressure readings for monitoring and/or control of hydraulic system pressure in workholding systems.

Reliable electrical control of hydraulic power

- Compact design minimizes space requirements on fixture
- Switch is easily adjustable to meet system requirements

IC series

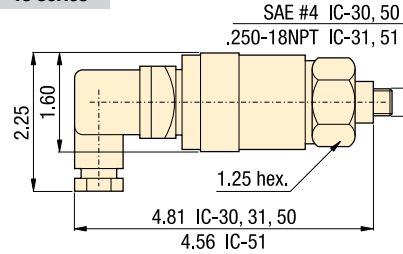

PSCK-8, 9

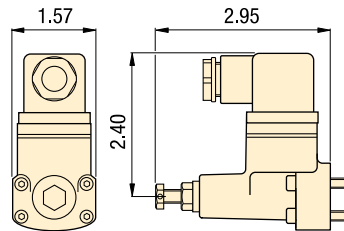

mounting dimensions

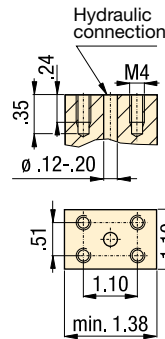

PB-4

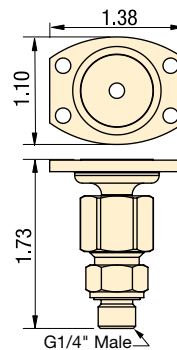

■ *Integrated in your hydraulic system, the pressure switch can be used to automate your clamping cycles.*



Pressure: 500-7500 psi

Accuracy: 2%

- (E) Presostatos
- (F) Pressostats
- (D) Druckschalter



Options

Fittings

194 ▶



Gauges

190 ▶



Important

Do not exceed the maximum pressure.

Product selection

| Adjustable pressure range | Electrical specifications | Model number | Deadband | Switch point repeatability | Oil port | lb |
|---------------------------------------|---------------------------|--------------|-----------|----------------------------|----------------|-----|
| psi | at 50/60 Hz | | psi | % of range | | |
| ▼ Electrical pressure switches | | | | | | |
| 500-3500 | 125 VAC @ 5 A | IC-30 | 100 - 500 | +/-2 | SAE #4 | 1.0 |
| 500-3500 | 125 VAC @ 5 A | IC-31 | 100 - 500 | +/-2 | .250-18 NPT | 1.0 |
| 3000-7500 | 125 VAC @ 5 A | IC-50 | 250 - 800 | +/-2 | SAE #4 | 1.0 |
| 3000-7500 | 125 VAC @ 5 A | IC-51 | 250 - 800 | +/-2 | .250-18 NPT | 1.0 |
| 1450-5000 | 115 VAC @ 2 A | PSCK-8 | 250 - 800 | +/-2 | Manifold mount | 0.8 |
| 290-3045 | 115 VAC @ 2 A | PSCK-9 | 250 - 800 | +/-2 | Manifold mount | 0.8 |
| - | - | PB-4 | - | - | G 1/4" | .25 |

Pressure: 0-20,000 psi

Accuracy: ± 0.25%

Voltage: 3 VDC (battery)

- E** Manómetros digitales
- F** Manomètres digitaux
- D** Digitale Manometer

Options

Fittings

194 ▶



Gauge adaptors

190 ▶



Important

Do not exceed the maximum pressure.

Gauges can be easily installed into the hydraulic system using GA-3 gauge adaptor.

191 ▶

Protective cover included

Fits over face of gauge for protection in harsh environments.

Easy and precise pressure monitoring

DGR-2

- Rated for system pressure up to 20,000 psi
- Displays in multiple units: psi, bar, mPA, kg/cm² (user selectable)
- Zero reset – ensures that gauge reads actual system pressure
- Batteries included, condition indicator on readout
- IP65 rated case design
- Shut off selectable – menu driven
- UL listed, CE and RoHS compliant

Shown: DGR-2



DGR-1B

▶ Enerpac digital pressure gauges offer greater accuracy and are easier to read than conventional dial gauges, greatly enhancing your ability to monitor and control hydraulic system pressure.

DGR-2 Remote Operation

Battery operated for additional flexibility. Includes maximum and minimum pressure capture.

Back-lit Readout

Back-lit readout allows easy reading in less than ideal lighting.

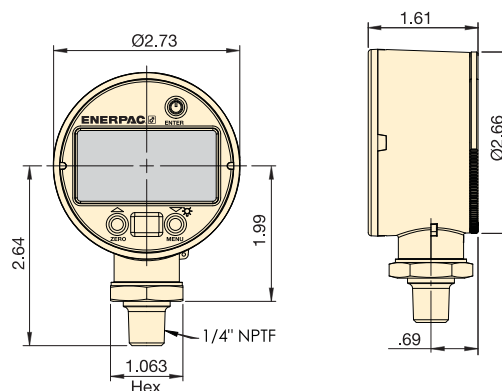

Product selection

| Pressure rating | | Model | Pressure rating | | Pressure rating | | Pressure rating | | |
|-----------------|------------|--------------|-----------------|------------|-----------------|------------|--------------------|------------|-----|
| psi | | | bar | | MPa | | Kg/cm ² | | |
| Range | Resolution | | Range | Resolution | Range | Resolution | Range | Resolution | lbs |
| 0-20,000 | 1 | DGR-2 | 0-1380 | 0.1 | 0-140 | 0.01 | 0-1400 | 0.1 | 0.5 |

Shown: GS-2, G-2512L, GS-3



Enerpac gauges provide a safe and inexpensive monitoring system for your hydraulic circuit

Highly reliable and accurate pressure sensing

- ± 1.5% accuracy of full scale
- All pressure sensing parts sealed and dampened by glycerine for long life
- Includes safety blow-out disk and pressure equalizing membrane to prevent overpressurization
- Copper alloy, coiled safety Bourdon tube for 1000 psi and higher
- Dual psi and bar scale readings, 2.5 inch gauge face

Gauge accessories for easy installation

- Needle valves providing positive shut-off
- 303 stainless steel stem (NV-251)
- Snubber valves to control pressure surges between gauge and hydraulic system
- Gauge adaptors – male end screws into pump or cylinder, female port accepts hose or coupler, the third port is for gauge connection
- FM-25NG for panel mounting of 2.50 inch diameter gauges

Product selection

| Pressure gauge mounting style | Pressure range | | Model number | PSI graduation | | Bar graduation | | A in | B in | D in | G |
|---------------------------------------|----------------|-------|-----------------|----------------|-----------|----------------|-----------|---------|---------|---------|----------|
| | psi | bar | | Major psi | Minor psi | Major bar | Minor bar | | | | |
| ▼ Pressure gauge – Lower mount | | | | | | | | | | | |
| | 0-100 | 0-7 | G-2509L | 10 | 2 | 1 | 0,01 | 3.31 | 1.46 | 2.50 | 1/4" NPT |
| | 0-160 | 0-11 | G-2510L | 10 | 2 | 1 | 0,02 | 3.31 | 1.46 | 2.50 | 1/4" NPT |
| | 0-200 | 0-14 | G-2511L | 50 | 5 | 1 | 0,02 | 3.31 | 1.46 | 2.50 | 1/4" NPT |
| | 0-300 | 0-20 | G-2512L | 50 | 5 | 5 | 0,05 | 3.31 | 1.46 | 2.50 | 1/4" NPT |
| | 0-600 | 0-40 | G-2513L | 100 | 10 | 10 | 1 | 3.31 | 1.46 | 2.50 | 1/4" NPT |
| | 0-1000 | 0-70 | G-2514L | 100 | 20 | 10 | 1 | 3.31 | 1.46 | 2.50 | 1/4" NPT |
| | 0-2000 | 0-140 | G-2515L | 500 | 50 | 10 | 2 | 3.31 | 1.46 | 2.50 | 1/4" NPT |
| | 0-3000 | 0-200 | G-2516L | 500 | 50 | 50 | 5 | 3.31 | 1.46 | 2.50 | 1/4" NPT |
| | 0-6000 | 0-400 | G-2517L | 1000 | 100 | 100 | 10 | 3.31 | 1.46 | 2.50 | 1/4" NPT |
| | 0-10,000 | 0-700 | G-2535L | 2000 | 200 | 100 | 10 | 3.31 | 1.46 | 2.50 | 1/4" NPT |
| | 0-1000 | 0-70 | G-2514SL | 100 | 20 | 10 | 1 | 3.66 | 1.23 | 2.50 | SAE#4 |
| | 0-3000 | 0-200 | G-2516SL | 500 | 50 | 50 | 5 | 3.66 | 1.23 | 2.50 | SAE#4 |
| | 0-6000 | 0-400 | G-2517SL | 1000 | 100 | 100 | 10 | 3.66 | 1.23 | 2.50 | SAE#4 |
| | 0-10,000 | 0-700 | G-2535SL | 2000 | 200 | 100 | 10 | 3.66 | 1.23 | 2.50 | SAE#4 |
| ▼ Pressure gauge – Rear mount | | | | | | | | | | | |
| | 0-1000 | 0-70 | G-2531R | 100 | 20 | 10 | 1 | 2.48 | 1.46 | 2.50 | 1/4" NPT |
| | 0-6000 | 0-400 | G-2534R | 1000 | 100 | 100 | 10 | 2.48 | 1.46 | 2.50 | 1/4" NPT |
| | 0-10,000 | 0-700 | G-2537R | 2000 | 200 | 100 | 10 | 2.48 | 1.46 | 2.50 | 1/4" NPT |
| | 0-1000 | 0-70 | G-2531SR | 100 | 20 | 10 | 1 | 2.46 | 1.23 | 2.50 | SAE #4 |
| | 0-3000 | 0-200 | G-2533SR | 500 | 50 | 50 | 5 | 2.46 | 1.23 | 2.50 | SAE #4 |
| | 0-6000 | 0-400 | G-2534SR | 1000 | 100 | 100 | 10 | 2.46 | 1.23 | 2.50 | SAE #4 |
| | 0-10,000 | 0-700 | G-2537SR | 2000 | 200 | 100 | 10 | 2.46 | 1.23 | 2.50 | SAE #4 |
| | 0-1000 | 0-70 | 1531R | 100 | 20 | 10 | 1 | 1.99 | 0.98 | 1.50 | 1/8" NPT |
| | 0-3000 | 0-200 | 1533R | 500 | 100 | 50 | 10 | 1.99 | 0.98 | 1.50 | 1/8" NPT |
| | 0-6000 | 0-400 | 1534R | 1000 | 100 | 100 | 10 | 1.99 | 0.98 | 1.50 | 1/8" NPT |
| | 0-10,000 | 0-700 | 1537R | 2000 | 200 | 100 | 10 | 1.99 | 0.98 | 1.50 | 1/8" NPT |

Collet-Lok® product line
 Swing clamps
 Work supports
 Linear clamps
 Power sources
 Valves
 Pallet components
 System components

Pressure: 0-10,000 psi

Accuracy: 1.5% /full scale

Gauge face: \varnothing 2.5 inch

GA-1

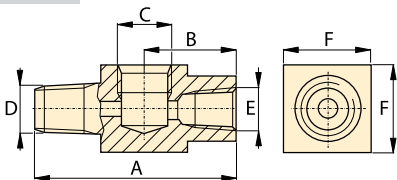

GA-2, -3, -4

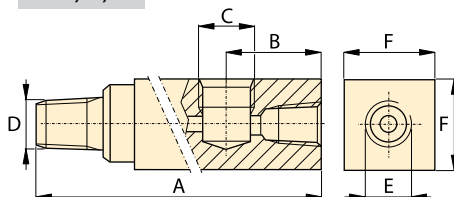

GA-918

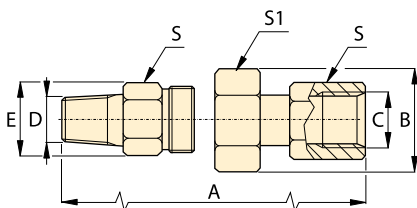

GS-2, -3

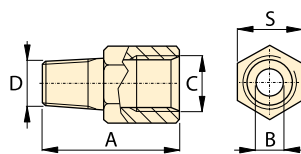

NV-251, V-91

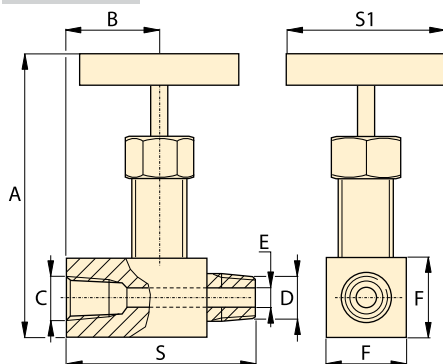

FM-25NG

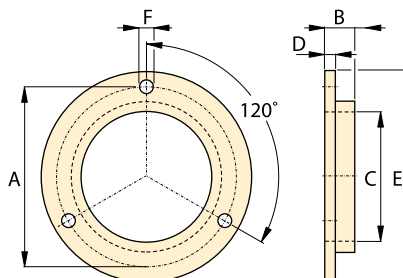

- E** Manómetros
- F** Manomètres
- D** Manometer

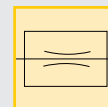

Options

Hoses and couplers

192 ▶



Digital gauges

189 ▶



Pressure switches

188 ▶



V-10 Auto Damper® valve

157 ▶



Important

Do not exceed maximum pressure.

Gauge snubbers or needle valves are recommended for high cycle applications.

Do not keep gauges under permanent pressure. The use of shut-off valves is recommended.

For basic system set-up information, refer to our "Yellow Pages" section.

202 ▶

Product dimensions in inches [\varnothing]

| Gauge port NPT | Max. pressure psi | Model number | Dimensions | | | | | | | |
|--|----------------------|----------------|------------|------|---------|---------|---------|------|------|------|
| | | | A | B | C | D | E | F | S | S1 |
| ▼ Gauge adaptors | | | | | | | | | | |
| 1/2" | 10,000 | GA-1 | 2.81 | 1.24 | 1/2"NPT | 3/8"NPT | 3/8"NPT | 1.25 | - | - |
| 1/2" | 10,000 | GA-2 | 6.10 | 1.38 | 1/2"NPT | 3/8"NPT | 3/8"NPT | 1.25 | - | - |
| 1/4" | 10,000 | GA-3 | 5.25 | 1.38 | 1/4"NPT | 3/8"NPT | 3/8"NPT | 1.25 | - | - |
| 1/2" | 10,000 | GA-4 | 4.38 | 1.38 | 1/2"NPT | 1/4"NPT | 3/8"NPT | 1.25 | - | - |
| ▼ Swivel gauge adaptor | | | | | | | | | | |
| 1/2" | 10,000 | GA-918 | 2.25 | 1.72 | 1/2"NPT | 1/2"NPT | 1.30 | - | 1.13 | 1.50 |
| ▼ Gauge shut-off valves | | | | | | | | | | |
| 1/4" | 10,000 | NV-251 | 2.25 | 1.14 | 1/4"NPT | 1/4"NPT | .17 | .75 | 2.25 | 2.50 |
| 1/2" | 10,000 | V-91 | 3.50 | 1.25 | 1/2"NPT | 1/2"NPT | .19 | 1.25 | 2.50 | 2.50 |
| ▼ Gauge snubber valves | | | | | | | | | | |
| 1/4" | 5000 | GS-2 | 1.63 | .018 | 1/4"NPT | SAE #4 | - | - | .75 | - |
| 1/4" | 5000 | GS-3 | 1.63 | .018 | 1/4"NPT | G1/4" | - | - | .75 | - |
| ▼ Flange mounting for panel mounting of G series gauges | | | | | | | | | | |
| - | - | FM-25NG | 2.95 | .17 | 2.51 | .07 | 3.35 | .14 | - | - |

Manifolds, couplers, hoses, tubing

Shown: HLS, HF, AH, AR, FL, T, A-series



Use genuine Enerpac manifolds, couplers, hoses and tubings to connect your workholding cylinders or fixtures to the hydraulic power source.

A series, Manifolds

For multiple hydraulic line connections at one central location directing oil to or from a pressure source.

AH/AR series, Couplers

Quick disconnect low leakage couplers for easy connection of hydraulic circuits.

HLS series, Hoses

High pressure hydraulic hoses, featuring a heavy-duty protective plastic coating.

T-series, Tubing

High pressure steel tubing, available in 5 ft. lengths.

Manifolds

- Easy to connect
- Mounting holes on all models

Couplers

- Spee-D-Coupler® design allows cylinder to be connected and disconnected in seconds
- For more safety: couplers cannot be connected or disconnected while under hydraulic pressure

Hydraulic hoses and tubings

- Heavy-duty coating for abrasion resistance
- Resistant against mineral based hydraulic oil as well as water glycols
- High pressure steel tubing for permanent installations

Important

Do not exceed the maximum pressure.

Inspect hoses and tubing frequently and replace as required.

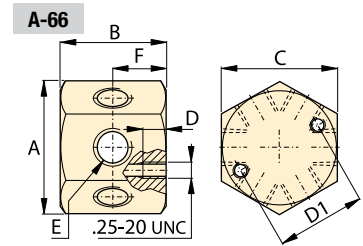
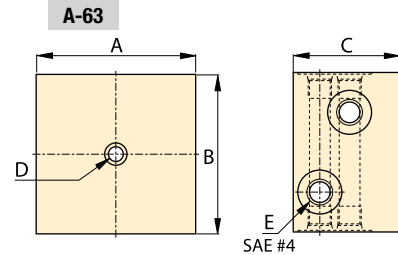
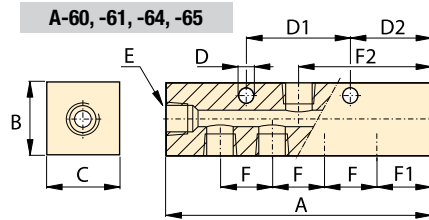

Manifolds dimensions in inches []

| Number of ports | Model number | A | B | C | D | D1 | D2 | E | F | F1 | F2 | Weight lbs |
|-----------------|--------------|------|------|------|-----|------|------|-------------|------|------|------|------------|
| 2 x 4 | A-63 | 3.00 | 3.00 | 2.00 | .25 | - | - | SAE #4 | - | - | - | 2.0 |
| 5 | A-60 | 3.50 | 1.25 | 1.25 | .28 | 1.50 | 1.00 | SAE #4 | 1.50 | 1.00 | 1.75 | 1.0 |
| 7 | A-61 | 6.50 | 1.25 | 1.25 | .28 | 1.50 | 1.25 | SAE #4 | 1.00 | 1.25 | 3.25 | 1.4 |
| 7 | A-64 | 7.00 | 1.25 | 1.25 | .25 | 3.00 | 1.25 | .375-18 NPT | 1.50 | 1.25 | 3.50 | 3.3 |
| 7 | A-65 | 14.5 | 1.25 | 1.25 | .25 | 8.00 | 1.25 | .375-18 NPT | 4.00 | 1.25 | 7.25 | 6.1 |
| 6 | A-66 | 2.30 | 1.63 | 2.00 | .52 | 1.50 | - | .375-18 NPT | - | - | - | 1.8 |

Couplers

AH-650

Male coupler half
.250-18 NPT

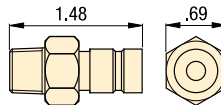

AH-652

Male coupler half
G1/4" BSPP

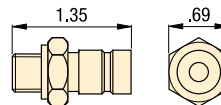

AH-654

Male coupler half
SAE #4 .437-20 UNF

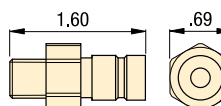

AR-650

Female coupler half
.250-18 NPT

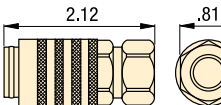

Hoses

| Length ft | Model number | Internal diameter in | Maximum pressure psi |
|--------------------------|--------------|----------------------|----------------------|
| ▼ 1/4", 37° flare | | | |
| 1 | HLS-512 | .19 | 5000 |
| 2 | HLS-524 | .19 | 5000 |
| 3 | HLS-536 | .19 | 5000 |
| 4 | HLS-548 | .19 | 5000 |
| 5 | HLS-560 | .19 | 5000 |
| 10 | HLS-5120 | .19 | 5000 |
| ▼ 3/8" NPT | | | |
| 3 | H-9203 | .25 | 10,000 |
| 6 | H-9206 | .25 | 10,000 |
| 10 | H-9210 | .25 | 10,000 |

Tubing

| Length ft | Model number | Internal diameter in | External diameter in | Max. pressure psi |
|-----------|--------------|----------------------|----------------------|-------------------|
| 5 | T-2560 | .152 | .25 | 5000 |

Options

Fittings

194 ▶



Collet-Lok® product line
Swing clamps
Work supports
Linear clamps
Power sources
Valves
Pallet components
System components

High-pressure filters

- Keep your hydraulic system clean
- Pleated stainless steel wire mesh screen construction provides large filter area in a compact size
- Rated for full system pressure up to 5000 psi
- Bi-directional design allows filtration of oil in either flow direction
- Two piece body construction for easy replacement of filter elements
- High flow rates are obtainable with a minimum pressure drop
- Threaded port connections on each end simplify installation

Hydraulic oil

- Ensures effective lubricity
- Protects essential parts

Filtration

20 micron filter provides the longest service life before element replacement

10 micron filter recommended for more sensitive hydraulic components

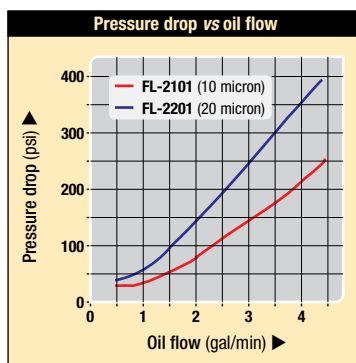

FL series

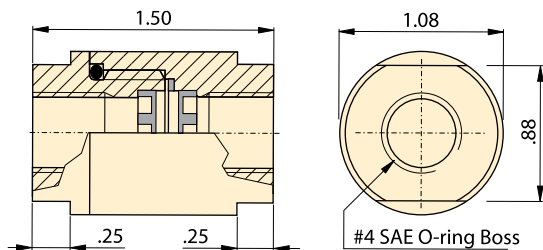

High in line pressure filters

| Model number | Filtration | | Filter element set | lbs |
|--------------|------------|----------|--------------------|-----|
| | Nominal | Absolute | | |
| FL-2101 | 10 | 25 | FL-2101K | .4 |
| FL-2201 | 20 | 40 | FL-2201K | .4 |

Hydraulic oil

| Contents | Model number | Specifications | |
|----------|--------------|-------------------------------|---------------|
| | | genuine Enerpac hydraulic oil | |
| Gal | | | |
| .25 | HF-100 | 0 °F | <12,000 S.U.S |
| 1 | HF-101 | 100 °F | 150/165 S.U.S |
| 5 | HF-102 | 210 °F | 42/45 S.U.S |
| 55 | HF-104 | Flash, C.O.C. | 400°F |
| | | Pour point | -25°F |
| | | Aniline point | 210/220 °F |

Note: Viscosity index: 100 min

www.enerpacwh.com

- E** Mangueras, Filtros Acoplamientos, Aceite
- F** Flexibles, Filtres Raccords, Huile
- D** Schläuche, Filter Kupplungen, Öl

High-pressure filters

Compact in line high pressure filters prevent chips and debris that have entered the hydraulic fluid system from damaging hydraulic system components.

Hydraulic oil

Use only genuine Enerpac hydraulic oil to guarantee optimal performance and long life of your hydraulic equipment.

Options

Fittings

 194



Important

Do not exceed the maximum pressure.

Hydraulic power is distributed by manifolds and transported by hoses and tubing.



Shown: FZ-2052, FZ-2054, FZ-2023



Fitting are used to connect all cylinders, components, power sources, tubes, gauges and hoses in a hydraulic system. Enerpac fittings provide flexible, safe and leak-free connections.

Proper connection for hydraulic components

- Male and female NPT, SAE, BSPP threaded fittings in common sizes allow easy connection of all components.
- BFZ and FZ-1000 models are 10,000 psi maximum pressure
- FZ-2000 models are 5000 psi maximum pressure

Product selection

| From | To | Max. pressure psi | Model number | Dimensions in inches | | | |
|--------------------------------|----------|----------------------|----------------|----------------------|---------|-------------|-------------|
| | | | | A | B | C | D |
| ▼ Adapters | | | | | | | |
| Female Male | | | | | | | |
| 1/4" NPT | 1/8" NPT | 10,000 | FZ-1642 | 1.21 | 3/4" | 1/8"-27 NPT | 1/4"-18 NPT |
| 3/8" NPT | 1/4" NPT | 10,000 | FZ-1055 | 1.44 | 7/8" | 1/4"-18 NPT | 3/8"-18 NPT |
| 1/2" NPT | 1/4" NPT | 10,000 | FZ-1633 | 1.69 | 1-1/8" | 1/4"-18 NPT | 1/2"-14 NPT |
| 1/2" NPT | 3/8" NPT | 10,000 | FZ-1634 | 1.69 | 1-1/8" | 3/8"-18 NPT | 1/2"-14 NPT |
| ▼ Reducers | | | | | | | |
| Female Male | | | | | | | |
| 1/4" NPT | 3/8" NPT | 10,000 | FZ-1630 | .86 | 3/4" | 1/4"-18 NPT | 3/8"-18 NPT |
| 1/4" NPT | 1/2" NPT | 10,000 | FZ-1661 | 1.11 | 7/8" | 1/4"-18 NPT | 1/2"-14 NPT |
| SAE #6 | SAE #8 | 5000 | FZ-2029 | 1.38 | 1-1/16" | 9/16"-18 | 3/4"-16 |
| ▼ NPT Male Nipples | | | | | | | |
| 1/4" NPT | 1/4" NPT | 10,000 | FZ-1608 | 1.45 | 5/8" | 1/4"-18 NPT | 1/4"-18 NPT |
| 3/8" NPT | 3/8" NPT | 10,000 | FZ-1617 | 1.45 | 3/4" | 3/8"-18 NPT | 3/8"-18 NPT |
| 3/8" NPT | 3/8" NPT | 10,000 | FZ-1619 | 2.00 | 3/4" | 3/8"-18 NPT | 3/8"-18 NPT |
| 3/8" NPT | G1/4" | 10,000 | BFZ-305 | 1.42 | 3/4" | 3/8"-18 NPT | G1/4"-19 |
| ▼ NPT Female Connectors | | | | | | | |
| 1/4" NPT | 1/4" NPT | 10,000 | FZ-1605 | 1.13 | 3/4" | 1/4"-18 NPT | 1/4"-18 NPT |
| 3/8" NPT | 1/4" NPT | 10,000 | FZ-1615 | 1.13 | 7/8" | 3/8"-18 NPT | 1/4"-18 NPT |
| 3/8" NPT | 3/8" NPT | 10,000 | FZ-1614 | 1.13 | 7/8" | 3/8"-18 NPT | 3/8"-18 NPT |
| 1/2" NPT | 3/8" NPT | 10,000 | FZ-1625 | 1.50 | 1-1/8" | 1/2"-14 NPT | 3/8"-18 NPT |
| ▼ NPT Elbows | | | | | | | |
| 1/4" NPT | 1/4" NPT | 10,000 | FZ-1638 | .88 | 3/4" | 1/4"-18 NPT | 1/4"-18 NPT |
| 3/8" NPT | 3/8" NPT | 10,000 | FZ-1610 | 1.02 | 7/8" | 3/8"-18 NPT | 3/8"-18 NPT |
| ▼ NPT Tee | | | | | | | |
| 1/4" NPT | 1/4" NPT | 10,000 | FZ-1637 | 1.76 | 3/4" | 1/4"-18 NPT | 1/4"-18 NPT |
| 3/8" NPT | 3/8" NPT | 10,000 | FZ-1612 | 2.04 | 7/8" | 3/8"-18 NPT | 3/8"-18 NPT |
| ▼ NPT Cross | | | | | | | |
| 3/8" NPT | 3/8" NPT | 10,000 | FZ-1613 | 2.04 | 7/8" | 3/8"-18 NPT | 3/8"-18 NPT |

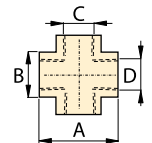
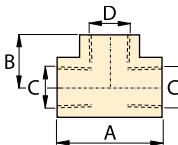
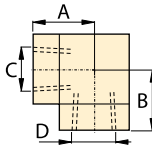
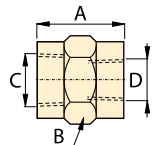
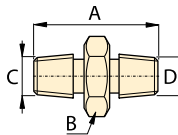
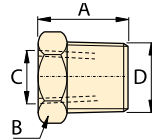
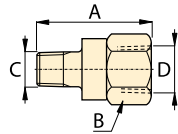

Multiple hydraulic line connections are easily installed with Enerpac fittings and manifolds.



Collet-Lok® product line
Swing clamps
Work supports
Linear clamps
Power sources
Valves
Pallet components
System components

 **Product selection**

| From | To | Max. pressure psi | Model number | Dimensions in inches | | | |
|------|----|----------------------|--------------|----------------------|---|---|---|
| | | | | A | B | C | D |

▼ **Adapters**

| Male | Female | Max. pressure psi | Model number | A | B | C | D |
|----------|----------|----------------------|--------------|------|--------|-------------|-------------|
| 1/8" NPT | SAE #4 | 5000 | FZ-2075 | 1.21 | 11/16" | 1/8"-27 NPT | 1/4"-18 NPT |
| 1/4" NPT | SAE #4 | 5000 | FZ-2042 | 1.31 | 11/16" | 1/4"-18 NPT | 7/16"-20 |
| 1/4" NPT | G1/4" | 10,000 | BFZ-16411 | 1.38 | 3/4" | 1/4"-18 NPT | G1/4" |
| SAE #4 | 1/8" NPT | 5000 | FZ-2008 | 1.00 | 9/16" | 7/16"-20 | 1/8"-27 NPT |
| SAE #4 | 1/4" NPT | 5000 | FZ-2007 | 1.16 | 3/4" | 7/16"-20 | 1/4"-18 NPT |
| SAE #2 | SAE #4 | 5000 | FZ-2022 | 1.03 | 11/16" | 5/16"-24 | 7/16"-20 |
| SAE #6 | 1/4" NPT | 5000 | FZ-2056 | 1.16 | 3/4" | 9/16"-18 | 1/4"-18 NPT |
| SAE #8 | 1/4" NPT | 5000 | FZ-2067 | 1.13 | 7/8" | 3/4"-16 | 1/4"-18 NPT |
| SAE #8 | 3/8" NPT | 5000 | FZ-2069 | 1.28 | 7/8" | 3/4"-16 | 3/8"-18 NPT |
| G 1/8" | 1/8" NPT | 5000 | FZ-2055 | .97 | 5/8" | G 1/8"-28 | 1/8"-27 NPT |
| G 1/8" | 1/4" NPT | 5000 | FZ-2060 | 1.28 | 3/4" | G 1/8"-28 | 1/4"-18 NPT |
| G 1/8" | #4 SAE | 5000 | FZ-2066 | 1.00 | 11/16" | G 1/8"-28 | 7/16"-20 |
| G 1/4" | 1/4" NPT | 5000 | FZ-2023 | 1.28 | 3/4" | G 1/4"-19 | 1/4"-18 NPT |
| G 1/4" | #4 SAE | 5000 | FZ-2065 | 1.11 | 3/4" | G 1/4"-19 | 7/16"-20 |

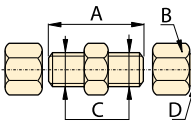
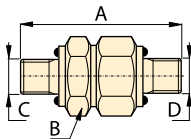
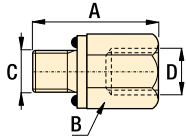

▼ **Straight union**

| | | | | | | | |
|--------|--------|------|---------|------|--------|----------|----------|
| SAE #4 | SAE #4 | 5000 | FZ-2005 | 1.27 | 9/16" | 7/16"-20 | 7/16"-20 |
| SAE #6 | SAE #6 | 5000 | FZ-2028 | 1.41 | 11/16" | 9/16"-18 | 9/16"-18 |
| SAE #8 | SAE #8 | 5000 | FZ-2040 | 1.56 | 7/8" | 3/4"-16 | 3/4"-16 |

▼ **Straight union to tube ends**

| | | | | | | | |
|------|------|------|-----------|------|------|----------|------|
| ø.25 | ø.25 | 5000 | FZ-2033* | 1.38 | 1/2" | 7/16"-20 | ø.25 |
| ø.25 | ø.25 | 5000 | FZ-2013** | 2.03 | 1/2" | 7/16"-20 | ø.25 |

▼ **Adaptors to tube end**

| Male | Tube size | Max. pressure psi | Model number | A | B | C | D |
|----------|-----------|----------------------|--------------|------|--------|-------------|-------|
| 1/8" NPT | ø.25 | 5000 | R-1054* | 1.22 | 1/2" | 1/8"-27 NPT | ø.25 |
| 1/4" NPT | ø.25 | 5000 | FZ-2020* | 1.42 | 9/16" | 1/4"-18 NPT | ø.25 |
| 1/4" NPT | ø.375 | 5000 | FZ-2072* | 1.43 | 5/8" | 1/4"-18 NPT | ø.375 |
| 1/4" NPT | ø.25 | 5000 | FZ-2012** | 1.32 | 9/16" | 1/4"-18 NPT | ø.25 |
| 3/8" NPT | ø.25 | 5000 | FZ-2061* | 1.44 | 3/4" | 3/8"-18 NPT | ø.25 |
| 3/8" NPT | ø.375 | 5000 | FZ-2068* | 1.44 | 3/4" | 3/8"-18 NPT | ø.375 |
| SAE #2 | ø.25 | 5000 | FZ-2025* | 1.02 | 9/16" | 5/16"-24 | ø.25 |
| SAE #4 | ø.25 | 5000 | FZ-2019* | 1.23 | 9/16" | 7/16"-20 | ø.25 |
| SAE #4 | ø.25 | 5000 | FZ-2001** | 1.13 | 9/16" | 7/16"-20 | ø.25 |
| SAE #6 | ø.25 | 5000 | FZ-2059* | 1.28 | 11/16" | 9/16"-18 | ø.25 |
| SAE #8 | ø.25 | 5000 | FZ-2039* | 1.38 | 7/8" | 3/4"-16 | ø.25 |
| SAE #8 | ø.375 | 5000 | FZ-2070* | 1.38 | 7/8" | 3/4"-16 | ø.375 |
| G1/8" | ø.25 | 5000 | FZ-2053* | 1.18 | 14 mm | G1/8"-28 | ø.25 |
| G1/4" | ø.25 | 5000 | FZ-2054* | 1.37 | 19 mm | G1/4"-19 | ø.25 |
| G1/4" | ø.375 | 5000 | FZ-2064* | 1.38 | 19 mm | G1/4"-19 | ø.375 |

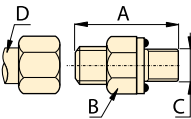

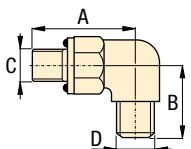

▼ **Elbow to tube end**

| Male | Tube size | Max. pressure psi | Model number | A | B | C | D |
|----------|-----------|----------------------|--------------|------|-------|-------------|-------|
| 1/8" NPT | ø.25 | 5000 | FZ-2074* | 0.78 | 7/16" | 1/8"-27 NPT | ø.25 |
| 1/4" NPT | ø.25 | 5000 | FZ-2073* | 1.09 | 9/16" | 1/4"-18 NPT | ø.25 |
| 1/4" NPT | ø.25 | 5000 | FZ-2076** | 1.09 | 9/16" | 1/4"-18 NPT | ø.25 |
| 1/4" NPT | ø.375 | 5000 | FZ-2081* | 1.09 | 9/16" | 1/4"-18 NPT | ø.375 |
| 3/8" NPT | ø.25 | 5000 | FZ-2082* | 1.22 | 3/4" | 3/8"-18 NPT | ø.25 |
| 3/8" NPT | ø.375 | 5000 | FZ-2083* | 1.22 | 3/4" | 3/8"-18 NPT | ø.375 |
| SAE #2 | ø.25 | 5000 | FZ-2024* | 0.92 | 7/16" | 5/16"-24 | ø.25 |
| SAE #4 | ø.25 | 5000 | FZ-2035* | 1.03 | 9/16" | 7/16"-20 | ø.25 |
| SAE #4 | ø.25 | 5000 | FZ-2002** | 1.03 | 9/16" | 7/16"-20 | ø.25 |
| SAE #8 | ø.375 | 5000 | FZ-2071* | 1.45 | 7/8" | 3/4"-16 | ø.375 |
| G1/8" | ø.25 | 5000 | FZ-2051* | 1.03 | 14mm | G1/8"-28 | ø.25 |
| G1/4" | ø.25 | 5000 | FZ-2052* | 1.25 | 19mm | G1/4"-19 | ø.25 |
| ø.25 | ø.25 | 5000 | FZ-2014** | 0.89 | 9/16" | ø.25 | ø.25 |



*Flared
**Flareless

- Pressure: 0-10,000 psi
- Threads: NPT, SAE, BSPP
- For tubing: .25 in/.375 in/8mm

-  Acoplamiento
-  Raccords
-  Verschraubungen

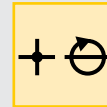

 **Options**

Gauges



190 ▶

Manifolds, couplers, hoses, tubing



192 ▶

 **Important**

Do not exceed the maximum pressure.

Use fittings and tubing in high cycle applications and areas having excessive heat or weld splatter.

To seal NPT threads use anaerobic thread sealers or Teflon paste. Apply Teflon tape one thread from the end of the fitting, to prevent it from winding up in the hydraulic system.

High pressure hydraulic fittings allow connection of many components with minimum effort.



Pressure: 0-5000 psi

Threads: NPT, SAE, BSPP

For tubing: .25 in/.375 in/8mm

- E** Acoplamientos
- F** Raccords
- D** Verschraubungen

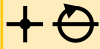

Options

Manifolds, couplers, hoses, tubing

192 ▶



Important

Do not exceed maximum pressure.

Use fittings and tubing in high cycle applications and areas having excessive heat or weld splatter.

High pressure fittings enable the design of hydraulic systems to meet a variety of applications.



99-080

Product selection

| From | To | Max. pressure psi | Model number | Dimensions in inches | | | |
|--------------------------------------|-------|----------------------|------------------|----------------------|--------|-----------|-------|
| | | | | A | B | C | D |
| ▼ Swivel banjo BSPP to tube | | | | | | | |
| Male Tube size | | | | | | | |
| G1/4" | ø 8mm | 10,000 | BFZ-307** | 1.14 | 19mm | G1/4"-19 | ø 8mm |
| ▼ Swivel T-banjo BSPP to tube | | | | | | | |
| Male Tube size | | | | | | | |
| G 1/4" | ø 8mm | 10,000 | BFZ-309** | 1.14 | 19mm | G 1/4"-19 | ø 8mm |
| ▼ Union tee | | | | | | | |
| ø.25 | ø.25 | 5000 | FZ-2021* | 1.78 | 9/16" | 7/16"-20 | ø.25 |
| ø.25 | ø.25 | 5000 | FZ-2015** | 1.78 | 9/16" | 7/16"-20 | ø.25 |
| ▼ Branch tee | | | | | | | |
| Male Tube size | | | | | | | |
| SAE #4 | ø.25 | 5000 | FZ-2036* | 1.78 | 9/16" | 7/16"-20 | ø.25 |
| SAE #4 | ø.25 | 5000 | FZ-2004** | 1.78 | 9/16" | 7/16"-20 | ø.25 |
| ▼ Union cross | | | | | | | |
| ø.25 | ø.25 | 5000 | FZ-2034* | 1.78 | 9/16" | 7/16"-20 | ø.25 |
| ø.25 | ø.25 | 5000 | FZ-2016** | 1.78 | 9/16" | 7/16"-20 | ø.25 |
| ▼ SAE Plug | | | | | | | |
| SAE #4 | | 5000 | FZ-2006 | .11 | .56 | 7/16"-20 | |
| SAE #6 | | 5000 | FZ-2003 | .19 | .69 | 9/16"-18 | |
| ▼ SAE Hex Plug | | | | | | | |
| SAE #8 | | 5000 | FZ-2041 | .80 | 7/8" | 3/4"-16 | |
| ▼ Nut and Sleeve for Tubing | | | | | | | |
| ø.25 | | 5000 | FZ-2037* | .62 | 9/16" | 37° | ø.25 |
| ▼ Cap for Tubing | | | | | | | |
| ø.25 | | 5000 | FZ-2038* | .62 | 9/16" | 37° | ø.25 |
| ø.25 | | 5000 | FZ-2017** | .60 | 9/16" | ø.25 | ø.25 |
| ø.375 | | 5000 | FZ-2011* | .73 | 11/16" | 37° | ø.375 |

*Flared

**Flareless

