



Post Office Box 97
 Benton Harbor, Michigan
 Ph: 269/926-6171
 Fax: 269/925-8288

PART NUMBER: STD104
 REVISION: H

Product Specifications

Model Number	MAX. PRESS.		MAX. SPEED	HP	kW	Net Wt.	
	bar.	PSI				lbs.	kg
2AM-NRV-89	7.0	100	3,000 RPM	.95	0.70	4.2	1.9

SOUND LEVEL 76 dba MAX.

NORMAL AMBIENT +1°C. - 120°C.

RELATIVE HUMIDITY 0% - 100%

ENVIRONMENT HAZARDOUS AMBIENT COMBUSTIBLE
GAS AND DUST +1°C TO +40°C

* TECHNICAL DATA SUBJECT TO CHANGE WITHOUT NOTICE.

CONFORMS TO EUROPEAN STANDARD EN13463-1
 NON-ELECTRICAL EQUIPMENT FOR EXPLOSIVE
 ATMOSPHERES GROUP II CAT 2 (GAS & DUST),
 PROTECTED BY CONSTRUCTION (SURFACE TEMP. RATED 135°C).

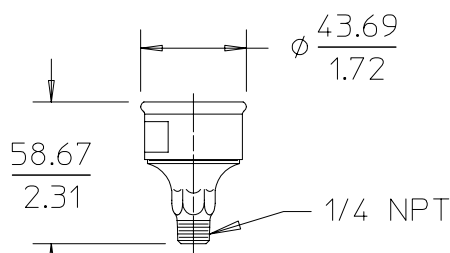
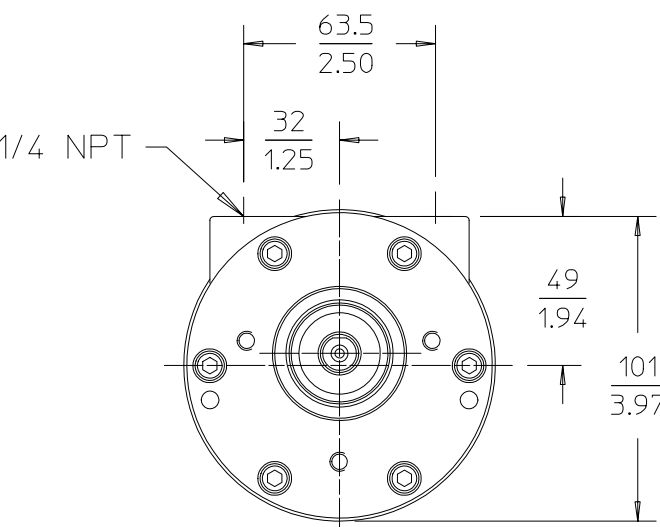
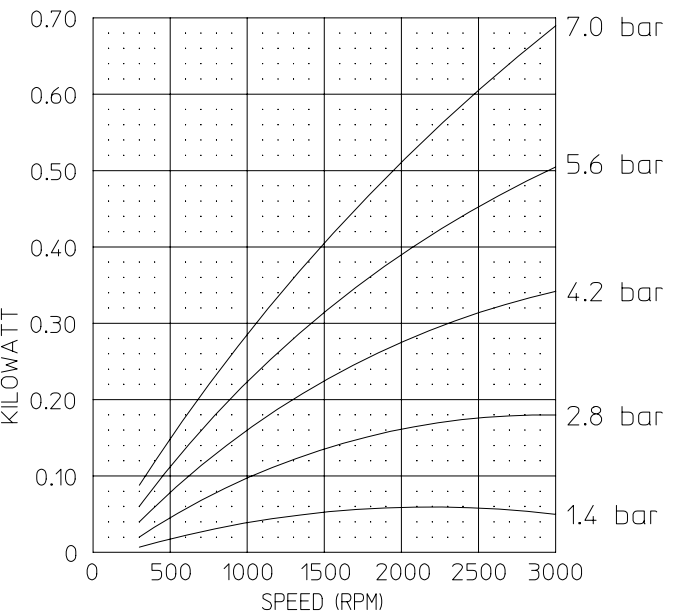
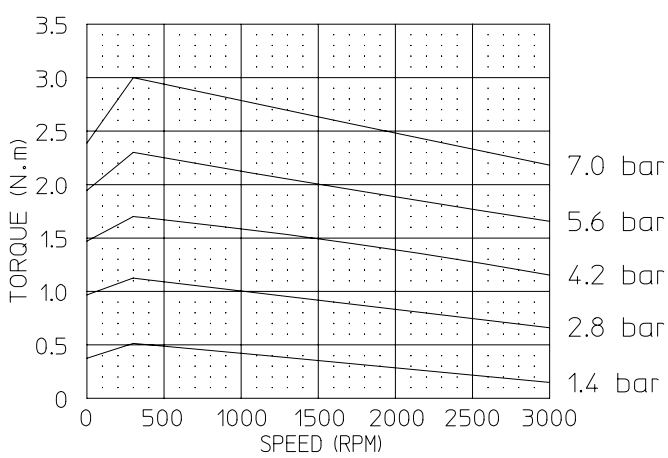
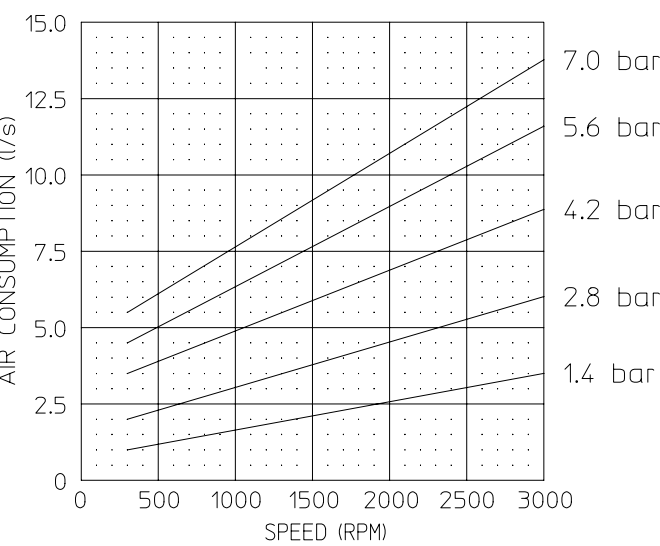
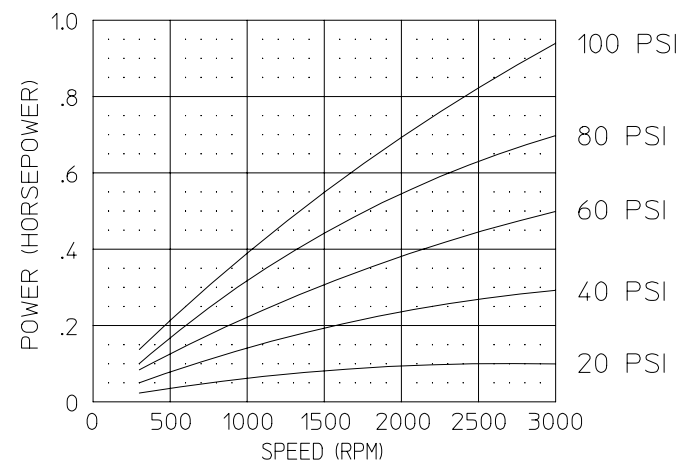
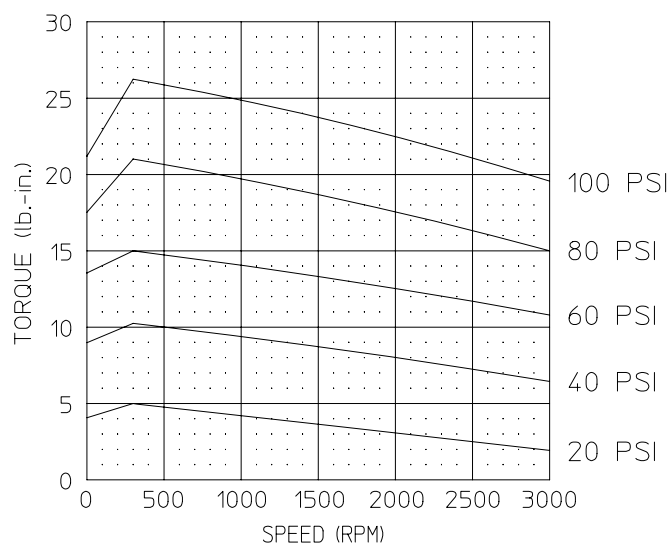
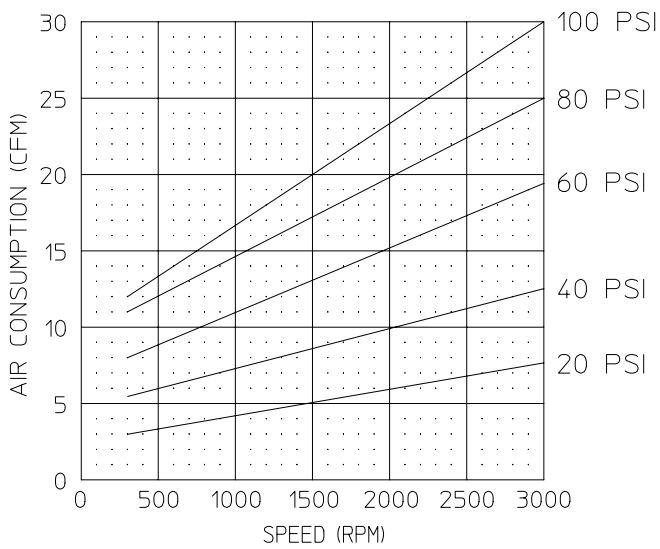

MUFFLER ASM.
(SHIPPED UNATTACHED)

