



Post Office Box 97
 Benton Harbor, Michigan
 Ph: 269/926-6171
 Fax: 269/925-8288

PART NUMBER:

STD309A

REV.

A

Model Number	Motor Voltage	RPM		HP	kW	Net Wt.	
		60 cycle	50 cycle			lbs.	kg
1023-V103-G608NEX	100-115/208-230	1725	----	3/4	0.56	50	22.7
	100-110/220-240	----	1425				

SOUND LEVEL LESS THAN 70 dB(A)
 NORMAL AMBIENT 1°C. - 40°C.
 RELATIVE HUMIDITY 8% - 100% NON CONDENSING
 ENVIRONMENT CLEAN DUST FREE

TECHNICAL DATA SUBJECT TO CHANGE WITHOUT NOTICE.
 SOLID LINE IS FOR 60 CYCLE PERFORMANCE.
 DASHED LINE IS FOR 50 CYCLE PERFORMANCE.
 DIMENSIONS ARE FOR REFERENCE ONLY UNLESS OTHERWISE TOLERANCED.

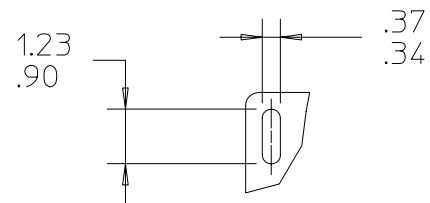
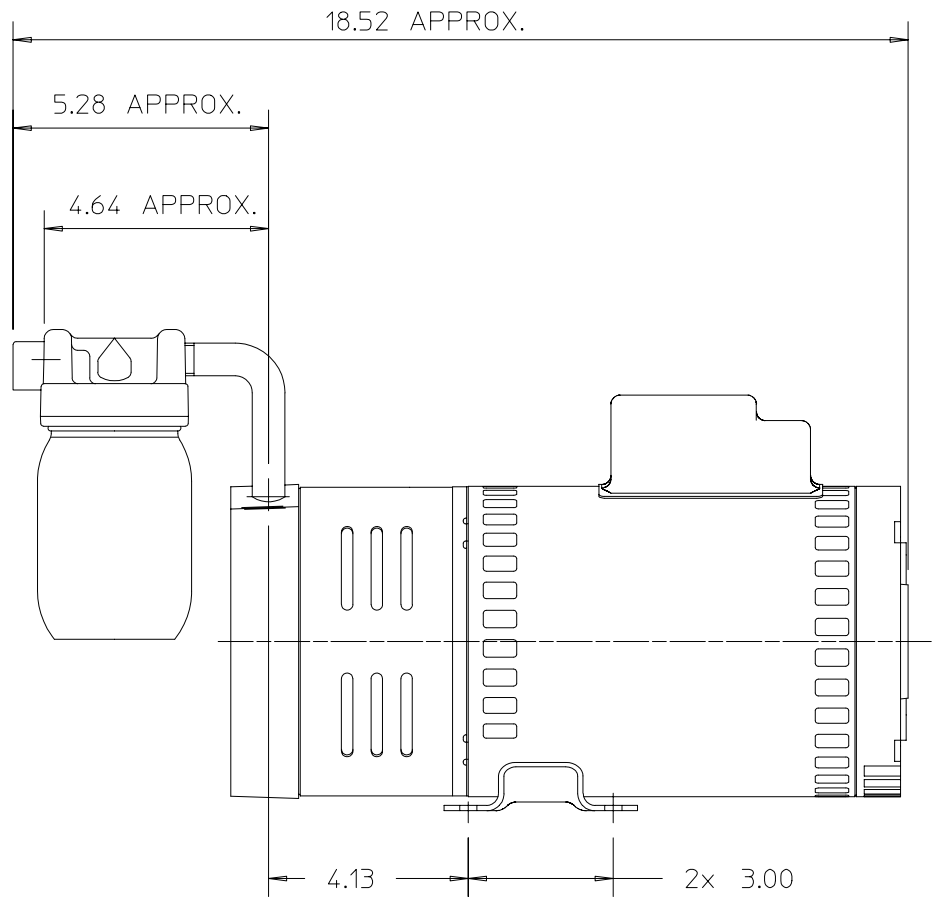
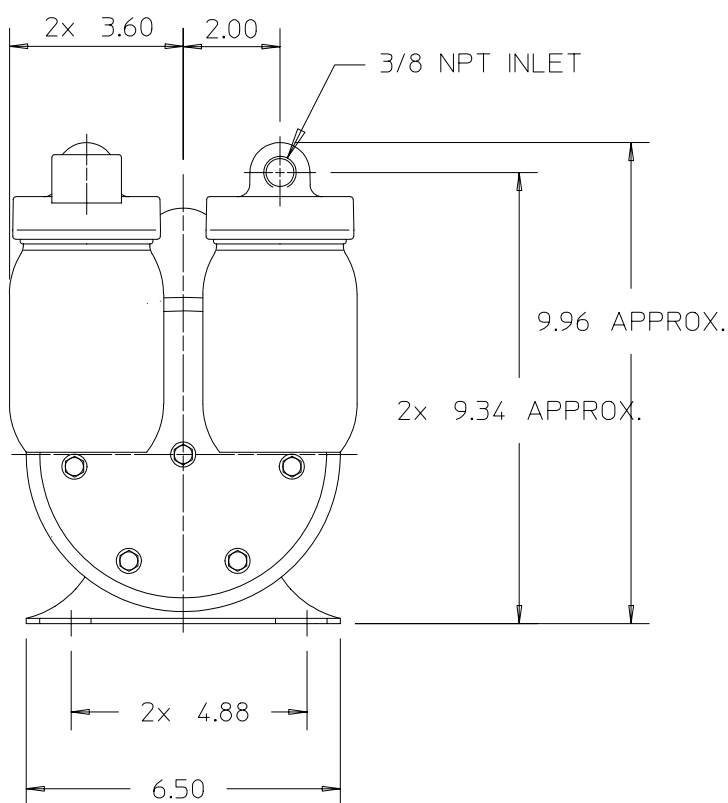
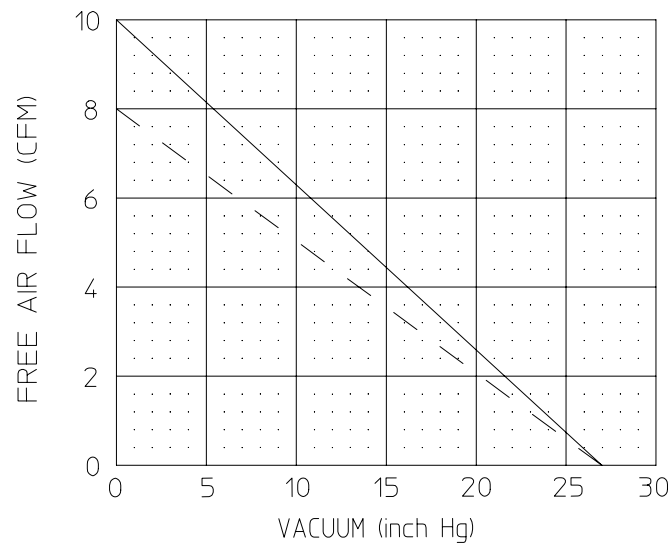
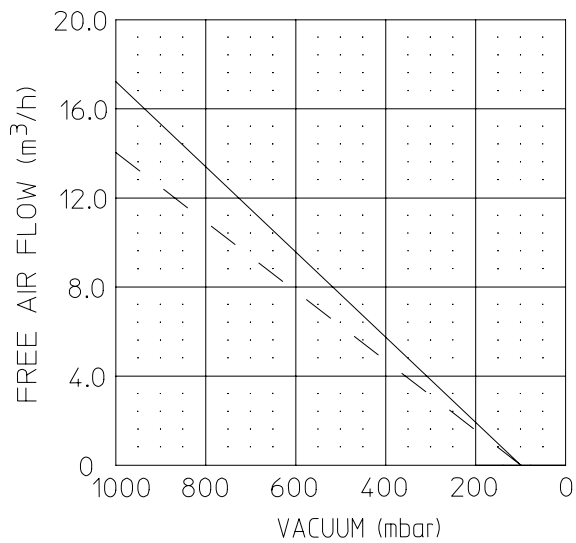

SLOT DETAIL (TYP. 4)